

Industrial Batteries / Network Power

Sonnenschein A700



»The durable high energy
 and reliable battery system«



www.norwatt.es

Industrial Batteries

The strong range of Network Power

Energy storage solutions for critical systems that require uninterrupted power supply. GNB® Industrial Power offers powerful batteries for your individual needs. The below table is only indicative and depends on customers' specific applications. For more information please ask a GNB sales representative.

Applica-tions	Battery ranges																			
	Sonnenschein						Marathon		Sprinter			Absolyte	Powerfit	Classic						
	A400/A600	A400 FT	A500	A700	SOLAR	RAIL	Power Cycle	M - FT	M/L/ XL	S	P/XP	XP - FT	GP/GX	S300	GRoE	OCSM	OPzS	Energy Bloc/OGi	Solar	rail
Telecom	●	●	●	●			●	●	●	●	●	●	●			●	●	●		
UPS		●	●	●			●	●	●	●	●	●	●			●		●		
Emergency lighting	●		●					●		●	●		●	●			●	●		
Security	●		●	●						●	●			●		●	●			
Utility	●	●		●			●	●	●			●			●	●	●	●		
Railways	●	●	●	●		●	●	●	●	●		●				●		●		●
Photovoltaic					●		●					●							●	
Universal	●	●	●	●			●	●	●	●	●	●	●	●		●	●	●		

The GNB Network Power brand overview

ABSOLYTE

MARATHON

> VRLA batteries (Valve Regulated Lead Acid) in which the electrolyte is fixed in an absorbent glass mat (AGM)

Sprinter

Powerfit

- > Excellent high current capability
- > Very economical
- > Maintenance-free (no topping up)



> VRLA batteries (Valve Regulated Lead Acid) in which the electrolyte is fixed in a gel (dryfit technology)

- > Inventor of Gel technology
- > Highest reliability, even in non-optimal conditions
- > Particularly suitable for cyclic applications
- > Maintenance-free (no topping up)

Classic

- > Conventional lead-acid batteries with liquid electrolyte
- > Extreme reliability, proven over decades
- > Low maintenance



> Further information about service is available on page 10

Sonnenschein A700

The durable high energy and reliable battery system

The benefit of the Sonnenschein A700 batteries result from the globally proved and successful dryfit technology. The Sonnenschein A700 combines excellent high current capability with a reliable energy storage capacity. Due to the dryfit technology the Sonnenschein A700 is maintenance free (no topping up) for the whole operating life.

Your benefits:

- > **dryfit Gel technology** – leak proof
- > **Lowest energy consumption** – saving costs
- > **Robust design** – resilient in harsh conditions
- > **Proof against deep discharge** – greater long-term energy delivery
- > **Completely recyclable** – low CO₂-footprint



Specifications

- > Nominal capacity 63 – 280 Ah C₁₀
- > Case material polypropylene (PP)
- > 6 volt and 4 volt blocks
- > Thick grid plates with high quality lead calcium alloy, for enhanced corrosion resistance and stability
- > Very low gassing due to internal gas recombination
- > Trouble-free transport of operational blocks, no restrictions for rail, road, sea and air transportation (IATA, DGR clause A67)
- > Designed in accordance with IEC 60896-21/-22
- > Design life: »> 12 years – Very Long Life« according to EUROBAT 2015 classification
- > Shelf life up to 2 years at 20 °C without recharge due to the very low self-discharge rate
- > Manufactured in Europe in our ISO 9001 certified production plants



Design life
> 12 Years -
Very Long
Life



Nominal
Capacity
63.0 – 280 Ah



Block battery



Grid plate



Recyclable



Valve regulated
lead-acid
batteries

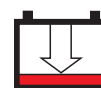

Proof
against deep
discharge



Maintenance
free (no
topping up)



Special high
Current
performance

Sonnenschein A700

Technical Data

Technical characteristics and data

Type	Part number	Type acc. to DIN 40 741 T1	Nom. voltage V	Nominal capacity $C_{10} 1.80$ Vpc 20 °C Ah	Length (l) max. mm	Width (b/w) max. mm	Height up to top of cover (h1) max. mm	Height Over terminals (h2) max. mm	Installed length mm	Weight approx. kg	Internal resistance mOhm	Short circuit current A	Terminal
A704/245	NGA7040245HS0FB	4V 7 OGiV 224	4	245	250	232	296	327	260	35.5	1.70	3181	F-M6
A704/280	NGA7040280HS0FB	4V 8 OGiV 256	4	280	250	232	296	327	260	37.5	1.17	3490	F-M6
A706/63	NGA7060063HS0FB	6V 3 OGiV 54	6	63.0	198	178	241	272	208	16.3	5.80	1058	F-M6
A706/84	NGA7060084HS0FB	6V 4 OGiV 72	6	84.0	198	178	241	272	208	18.3	4.30	1409	F-M6
A706/105	NGA7060105HS0FB	6V 5 OGiV 90	6	105	282	178	241	272	292	24.5	3.60	1726	F-M6
A706/126	NGA7060126HS0FB	6V 6 OGiV 108	6	126	282	178	241	272	292	26.2	2.90	2092	F-M6
A706/140	NGA7060140HS0FB	6V 4 OGiV 128	6	140	285	232	296	327	295	36.3	3.00	2083	F-M6
A706/175	NGA7060175HS0FB	6V 5 OGiV 160	6	175	285	232	296	327	295	39.7	2.60	2383	F-M6
A706/210	NGA7060210HS0FB	6V 6 OGiV 192	6	210	285	232	296	327	295	42.9	2.20	2876	F-M6

Container, approval, terminal and torque

- > **Container:** Polypropylene (PP)
- > **Approval:** Germanischer Lloyd (GL) · DIN/Gost/TÜV, Russia
Underwriter Laboratories (UL)

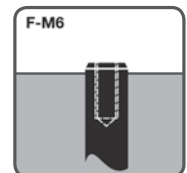

11 Nm

Sonnenschein A700

Drawings

A704/245

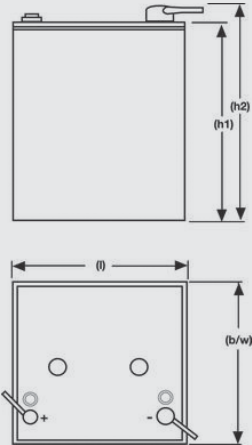

A704/280

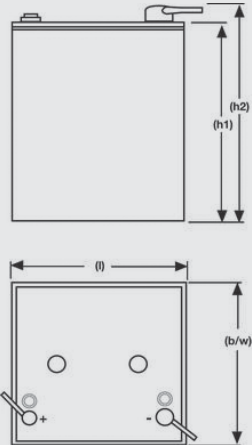

A706/63

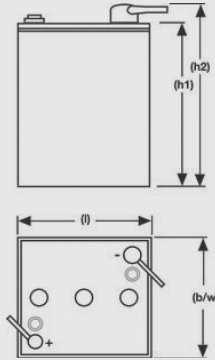

A706/84

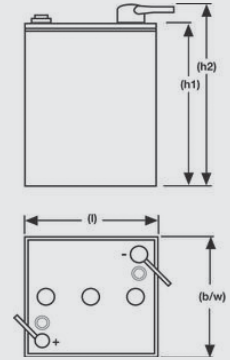

A706/105

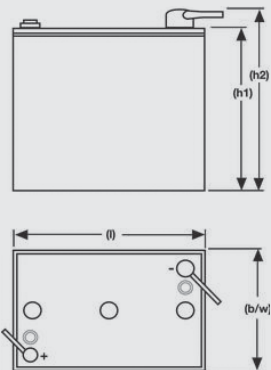

A706/126

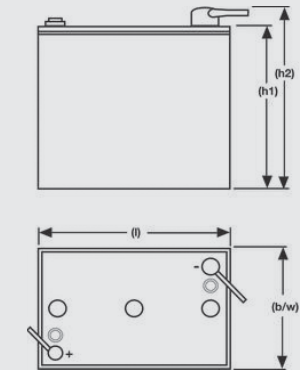

A706/140

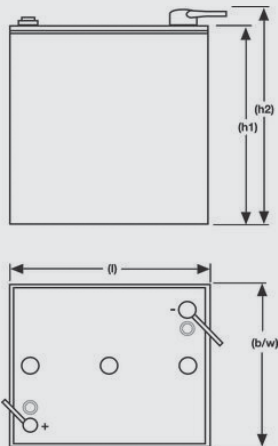

A706/175

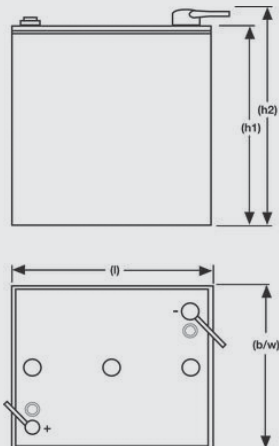

A706/210

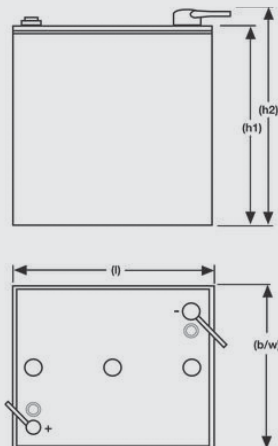

Sonnenschein A700

Constant current discharge

1.80 Vpc – Discharge in A at 20 °C

Type	Part number	5 Min	10 min	15 min	20 min	30 min	1 h	2 h	3 h	5 h	8 h	10 h
A704/245	NGA7040245HS0FB	356	332	283	252	220	143	88.3	64.9	44.8	30.4	24.5
A704/280	NGA7040280HS0FB	406	380	323	288	251	163	100	74.2	51.2	34.7	28.0
A706/63	NGA7060063HS0FB	108	93.9	79.2	69.3	56.7	34.5	21.9	16.5	11.1	7.70	6.30
A706/84	NGA7060084HS0FB	145	125	105	92.4	75.6	46.0	29.3	22.0	14.8	10.3	8.40
A706/105	NGA7060105HS0FB	181	156	132	115	94.5	57.5	36.6	27.6	18.5	12.9	10.5
A706/126	NGA7060126HS0FB	217	187	158	138	113	69.0	43.9	33.1	22.2	15.5	12.6
A706/140	NGA7060140HS0FB	203	190	161	144	125	81.8	50.5	37.1	25.6	17.4	14.0
A706/175	NGA7060175HS0FB	254	237	202	180	157	102	63.1	46.4	32.0	21.7	17.5
A706/210	NGA7060210HS0FB	305	285	242	216	188	122	75.7	55.7	38.4	26.0	21.0

1.77 Vpc – Discharge in A at 20 °C

Type	Part number	5 Min	10 min	15 min	20 min	30 min	1 h	2 h	3 h	5 h	8 h	10 h
A704/245	NGA7040245HS0FB	392	360	300	261	224	145	90.3	66.9	45.5	31.0	24.5
A704/280	NGA7040280HS0FB	448	411	343	299	256	166	103	76.5	51.9	35.4	28.0
A706/63	NGA7060063HS0FB	120	102	83.9	72.7	58.0	35.6	21.9	16.5	11.3	7.70	6.30
A706/84	NGA7060084HS0FB	160	136	111	97.0	77.3	47.4	29.3	22.0	15.1	10.3	8.40
A706/105	NGA7060105HS0FB	201	170	139	121	96.6	59.3	36.6	27.6	18.9	12.9	10.5
A706/126	NGA7060126HS0FB	241	205	167	145	115	71.2	43.9	33.1	22.6	15.5	12.6
A706/140	NGA7060140HS0FB	224	205	171	149	128	83.1	51.6	38.2	25.9	17.7	14.0
A706/175	NGA7060175HS0FB	280	257	214	187	160	103	64.5	47.8	32.4	22.1	17.5
A706/210	NGA7060210HS0FB	336	308	257	224	192	124	77.4	57.4	38.9	26.5	21.0

1.75 Vpc – Discharge in A at 20 °C

Type	Part number	5 Min	10 min	15 min	20 min	30 min	1 h	2 h	3 h	5 h	8 h	10 h
A704/245	NGA7040245HS0FB	417	378	311	268	227	147	91.6	68.3	45.8	31.4	24.5
A704/280	NGA7040280HS0FB	477	432	356	306	260	168	104	78.0	52.3	35.8	28.0
A706/63	NGA7060063HS0FB	128	108	87.0	75.0	58.8	36.6	21.9	16.5	11.3	7.70	6.30
A706/84	NGA7060084HS0FB	171	144	116	100	78.4	48.4	29.3	22.0	15.1	10.3	8.40
A706/105	NGA7060105HS0FB	214	180	145	125	98.0	60.5	36.6	27.6	18.9	12.9	10.5
A706/126	NGA7060126HS0FB	256	216	174	150	117	72.6	43.9	33.1	22.6	15.5	12.6
A706/140	NGA7060140HS0FB	238	216	178	153	130	84.0	52.3	39.0	26.2	17.9	14.0
A706/175	NGA7060175HS0FB	298	270	222	191	162	105	65.4	48.8	32.7	22.4	17.5
A706/210	NGA7060210HS0FB	357	324	267	230	195	126	78.5	58.5	39.2	26.9	21.0

Sonnenschein A700

Constant current discharge

1.70 Vpc – Discharge in A at 20 °C

Type	Part number	5 Min	10 min	15 min	20 min	30 min	1 h	2 h	3 h	5 h	8 h	10 h
A704/245	NGA7040245HS0FB	466	409	340	291	240	149	91.6	68.3	45.8	31.4	24.5
A704/280	NGA7040280HS0FB	532	468	389	332	275	170	104	78.0	52.3	35.8	28.0
A706/63	NGA7060063HS0FB	144	117	93.0	79.5	61.2	36.6	22.2	16.5	11.4	7.70	6.30
A706/84	NGA7060084HS0FB	192	156	124	106	81.6	48.4	29.7	22.0	15.3	10.3	8.40
A706/105	NGA7060105HS0FB	240	195	155	132	102	60.5	37.1	27.6	19.1	12.9	10.5
A706/126	NGA7060126HS0FB	288	234	186	159	122	72.6	44.5	33.1	22.9	15.5	12.6
A706/140	NGA7060140HS0FB	266	234	194	166	137	85.2	52.3	39.0	26.2	17.9	14.0
A706/175	NGA7060175HS0FB	333	292	243	208	172	106	65.4	48.8	32.7	22.4	17.5
A706/210	NGA7060210HS0FB	399	351	291	249	206	127	78.5	58.5	39.2	26.9	21.0

1.65 Vpc – Discharge in A at 20 °C

Type	Part number	5 Min	10 min	15 min	20 min	30 min	1 h	2 h	3 h	5 h	8 h	10 h
A704/245	NGA7040245HS0FB	508	431	353	299	243	149	91.9	68.6	45.8	31.4	24.5
A704/280	NGA7040280HS0FB	581	493	404	342	278	170	105	78.4	52.3	35.8	28.0
A706/63	NGA7060063HS0FB	156	123	97.5	80.7	61.2	36.6	22.2	16.9	11.4	7.70	6.30
A706/84	NGA7060084HS0FB	208	164	130	107	81.6	48.8	29.7	22.5	15.3	10.3	8.40
A706/105	NGA7060105HS0FB	260	205	162	134	102	61.0	37.1	28.1	19.1	12.9	10.5
A706/126	NGA7060126HS0FB	312	246	195	161	122	73.2	44.5	33.7	22.9	15.5	12.6
A706/140	NGA7060140HS0FB	290	246	202	171	139	85.3	52.5	39.2	26.2	17.9	14.0
A706/175	NGA7060175HS0FB	363	308	252	214	173	106	65.7	49.0	32.7	22.4	17.5
A706/210	NGA7060210HS0FB	436	369	303	256	208	128	78.8	58.8	39.2	26.9	21.0

1.60 Vpc – Discharge in A at 20 °C

Type	Part number	5 Min	10 min	15 min	20 min	30 min	1 h	2 h	3 h	5 h	8 h	10 h
A704/245	NGA7040245HS0FB	541	444	364	303	243	149	91.9	68.6	45.8	31.4	24.5
A704/280	NGA7040280HS0FB	619	507	416	346	278	170	105	78.4	52.3	35.8	28.0
A706/63	NGA7060063HS0FB	165	127	99.6	80.7	61.5	36.6	22.2	16.9	11.4	7.70	6.30
A706/84	NGA7060084HS0FB	220	170	132	107	82.0	48.8	29.7	22.5	15.3	10.3	8.40
A706/105	NGA7060105HS0FB	275	212	166	134	102	61.0	37.1	28.1	19.1	12.9	10.5
A706/126	NGA7060126HS0FB	330	255	199	161	123	73.2	44.5	33.7	22.9	15.5	12.6
A706/140	NGA7060140HS0FB	309	253	208	173	139	85.3	52.5	39.2	26.2	17.9	14.0
A706/175	NGA7060175HS0FB	387	317	260	216	173	106	65.7	49.0	32.7	22.4	17.5
A706/210	NGA7060210HS0FB	464	380	312	260	208	128	78.8	58.8	39.2	26.9	21.0

Sonnenschein A700

Constant power discharge

1.80 Vpc – Discharge in W/block at 20 °C

Type	Part number	5 Min	10 min	15 min	20 min	30 min	1 h	2 h	3 h	5 h
A704/245	NGA7040245HS0FB	1175	1034	944	855	747	512	344	254	173
A704/280	NGA7040280HS0FB	1342	1182	1079	977	854	585	393	290	198
A706/63	NGA7060063HS0FB	558	472	411	362	292	194	123	93.0	63.0
A706/84	NGA7060084HS0FB	744	629	548	482	389	258	164	124	84.0
A706/105	NGA7060105HS0FB	930	786	685	603	486	323	205	155	105
A706/126	NGA7060126HS0FB	1115	944	822	724	584	388	246	186	126
A706/140	NGA7060140HS0FB	1007	886	809	733	640	439	295	218	148
A706/175	NGA7060175HS0FB	1259	1108	1012	916	801	548	368	272	185
A706/210	NGA7060210HS0FB	1510	1330	1214	1099	961	658	442	327	222

1.77 Vpc – Discharge in W/block at 20 °C

Type	Part number	5 Min	10 min	15 min	20 min	30 min	1 h	2 h	3 h	5 h
A704/245	NGA7040245HS0FB	1264	1111	1002	906	768	523	350	258	175
A704/280	NGA7040280HS0FB	1445	1270	1145	1035	878	598	400	295	200
A706/63	NGA7060063HS0FB	596	496	432	377	300	197	125	93.0	63.0
A706/84	NGA7060084HS0FB	795	661	576	503	401	263	166	124	84.0
A706/105	NGA7060105HS0FB	994	826	719	629	501	328	208	155	105
A706/126	NGA7060126HS0FB	1193	992	863	755	601	394	249	186	126
A706/140	NGA7060140HS0FB	1083	952	859	776	659	449	300	222	150
A706/175	NGA7060175HS0FB	1354	1190	1074	971	823	561	375	277	188
A706/210	NGA7060210HS0FB	1625	1428	1288	1165	988	673	450	332	225

1.75 Vpc – Discharge in W/block at 20 °C

Type	Part number	5 Min	10 min	15 min	20 min	30 min	1 h	2 h	3 h	5 h
A704/245	NGA7040245HS0FB	1353	1187	1060	957	790	535	353	260	176
A704/280	NGA7040280HS0FB	1547	1357	1211	1094	902	611	404	297	201
A706/63	NGA7060063HS0FB	635	520	452	393	309	200	126	96.0	63.0
A706/84	NGA7060084HS0FB	847	693	603	524	412	267	168	128	84.0
A706/105	NGA7060105HS0FB	1058	866	754	655	515	334	210	160	105
A706/126	NGA7060126HS0FB	1270	1040	905	786	618	400	252	192	126
A706/140	NGA7060140HS0FB	1160	1018	908	820	677	458	303	223	151
A706/175	NGA7060175HS0FB	1450	1272	1135	1025	846	573	379	279	189
A706/210	NGA7060210HS0FB	1740	1527	1363	1230	1015	688	454	335	226

Sonnenschein A700

Constant power discharge

1.70 Vpc – Discharge in W/block at 20 °C

Type	Part number	5 Min	10 min	15 min	20 min	30 min	1 h	2 h	3 h	5 h
A704/245	NGA7040245HS0FB	1519	1313	1162	1025	825	546	358	262	176
A704/280	NGA7040280HS0FB	1736	1501	1328	1172	943	624	409	300	202
A706/63	NGA7060063HS0FB	689	568	477	412	319	203	129	96.0	65.0
A706/84	NGA7060084HS0FB	919	758	636	550	425	271	172	128	86.0
A706/105	NGA7060105HS0FB	1148	947	795	687	532	338	215	160	108
A706/126	NGA7060126HS0FB	1378	1137	954	825	638	406	258	192	129
A706/140	NGA7060140HS0FB	1302	1125	996	879	707	468	307	225	151
A706/175	NGA7060175HS0FB	1628	1407	1245	1098	884	585	383	281	189
A706/210	NGA7060210HS0FB	1954	1688	1494	1318	1060	702	460	337	227

1.65 Vpc – Discharge in W/block at 20 °C

Type	Part number	5 Min	10 min	15 min	20 min	30 min	1 h	2 h	3 h	5 h
A704/245	NGA7040245HS0FB	1634	1393	1226	1070	846	551	359	263	177
A704/280	NGA7040280HS0FB	1868	1592	1401	1223	967	630	410	300	203
A706/63	NGA7060063HS0FB	753	605	492	423	324	204	129	96.0	65.0
A706/84	NGA7060084HS0FB	1003	807	655	564	432	272	172	128	86.0
A706/105	NGA7060105HS0FB	1254	1008	819	705	540	340	215	160	108
A706/126	NGA7060126HS0FB	1505	1210	983	846	648	408	258	192	129
A706/140	NGA7060140HS0FB	1401	1194	1051	917	725	472	308	225	152
A706/175	NGA7060175HS0FB	1751	1492	1313	1147	906	591	385	282	190
A706/210	NGA7060210HS0FB	2101	1790	1576	1376	1087	709	462	338	228

1.60 Vpc – Discharge in W/block at 20 °C

Type	Part number	5 Min	10 min	15 min	20 min	30 min	1 h	2 h	3 h	5 h
A704/245	NGA7040245HS0FB	1762	1476	1285	1098	858	553	360	264	177
A704/280	NGA7040280HS0FB	2014	1687	1468	1255	980	633	411	301	203
A706/63	NGA7060063HS0FB	798	630	503	429	326	205	129	96.0	66.0
A706/84	NGA7060084HS0FB	1064	840	670	571	435	273	172	128	88.0
A706/105	NGA7060105HS0FB	1329	1050	838	714	544	341	215	160	110
A706/126	NGA7060126HS0FB	1595	1260	1005	857	653	409	258	192	132
A706/140	NGA7060140HS0FB	1510	1265	1101	941	735	474	309	226	152
A706/175	NGA7060175HS0FB	1888	1582	1376	1177	919	593	386	283	190
A706/210	NGA7060210HS0FB	2265	1898	1652	1412	1103	712	463	339	228

Battery Service – Energy Solutions

Keeping your business on the move

GNB® is the Expert

Who could do this job better than the professionals of a company with more than 100 years of experience in battery development, production and application?

Leave the responsibility for the maintenance of your batteries and chargers to the professionals: a GNB service contract provides you with exceptional economic advantages through time savings, cost savings and safety!



Installation of Batteries and Systems for Network Power

- > Development of complete turnkey solutions from the design concept to installation and commissioning.
- > Installation according to legal and safety regulations including CE certification by approved installation technicians.
- > Training and certification of external installation technicians according to CE regulations.

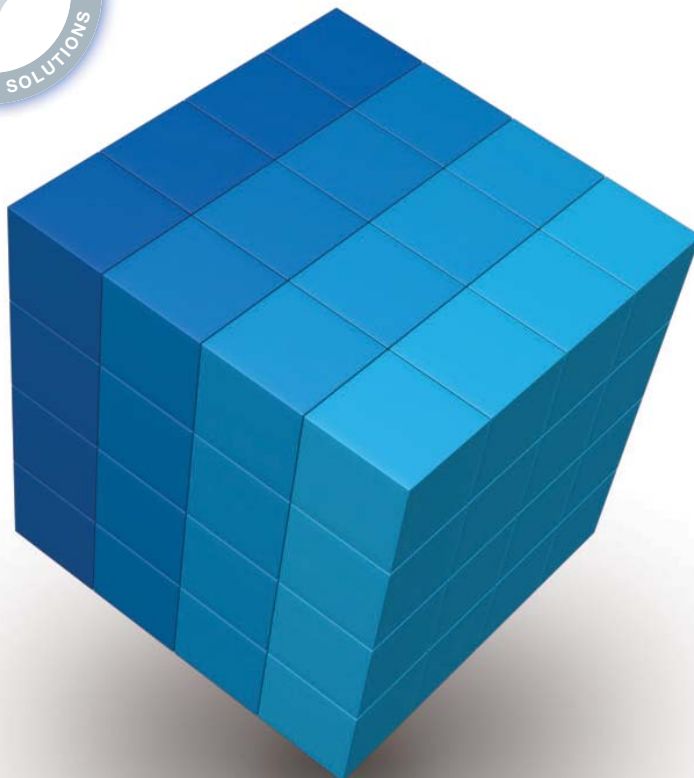

- ✦ Inspection Contract
- ✦ Maintenance Contract
- ✦ Lifetime Warranty Contract
- ✦ Full Service Contract



»GNB Service – individualized, professional and all over Europe!«

Sonnenschein A700

Notes

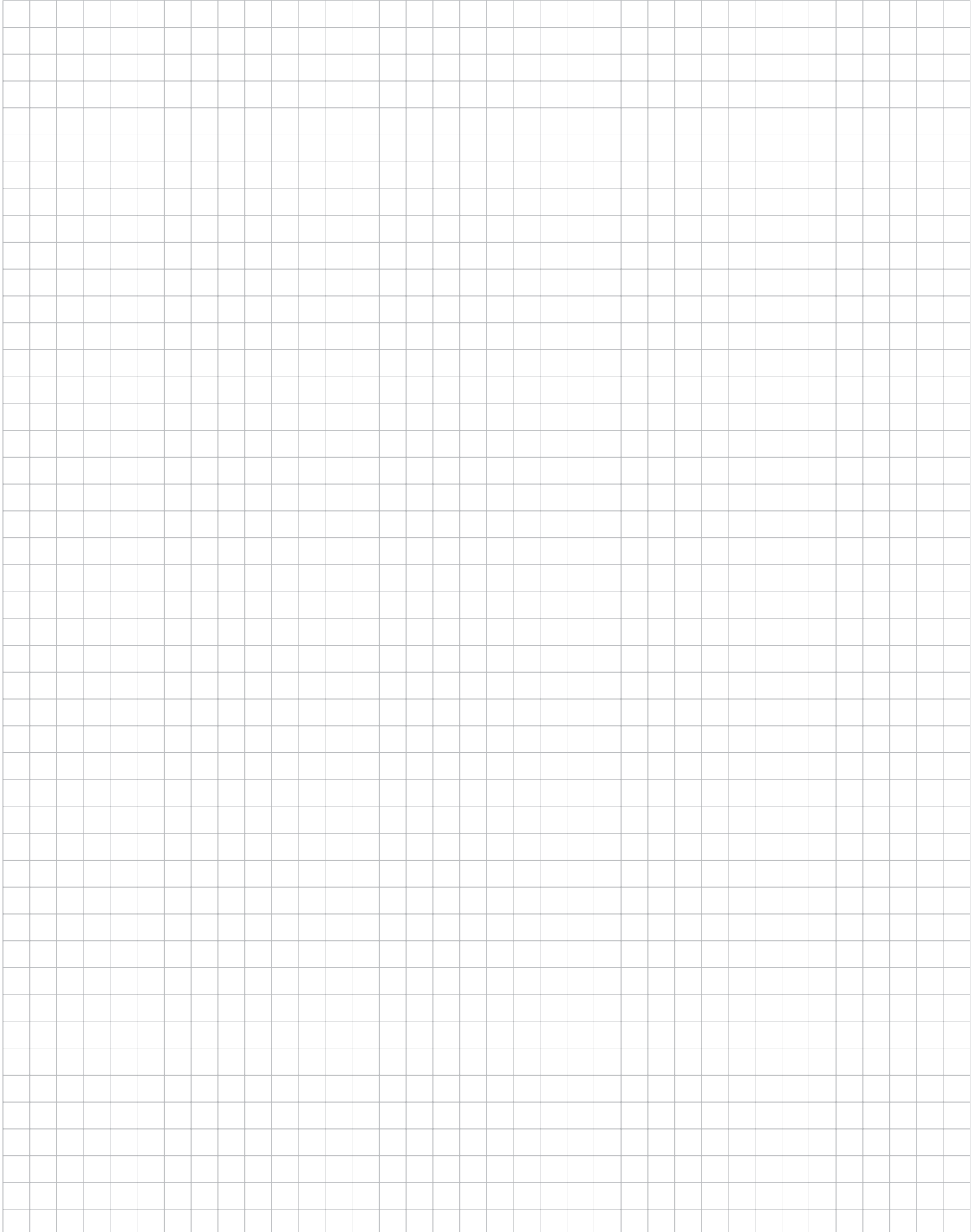



Exide Technologies, with operations in more than 80 countries, is one of the world's largest producers and recyclers of lead-acid batteries. Exide Technologies provides a comprehensive and customized range of stored electrical energy solutions. Based on over 120 years of experience in the development of innovative technologies, Exide Technologies is an esteemed partner of OEMs and serves the spare parts market for industrial and automotive applications.

GNB Industrial Power – A division of Exide Technologies – offers an extensive range of storage products and services, including solutions for telecommunication systems, railway applications, mining, photovoltaic (solar energy), uninterrupted power supply (UPS), electrical power generation and distribution, fork lifts and electric vehicles.

Exide Technologies takes pride in its commitment to a better environment. An integrated approach to manufacturing, distributing and recycling of lead-acid batteries has been developed to ensure a safe and responsible life cycle for all of its products.